

# SI-1365

## 3/8" Sq. Dr. Impact Wrench

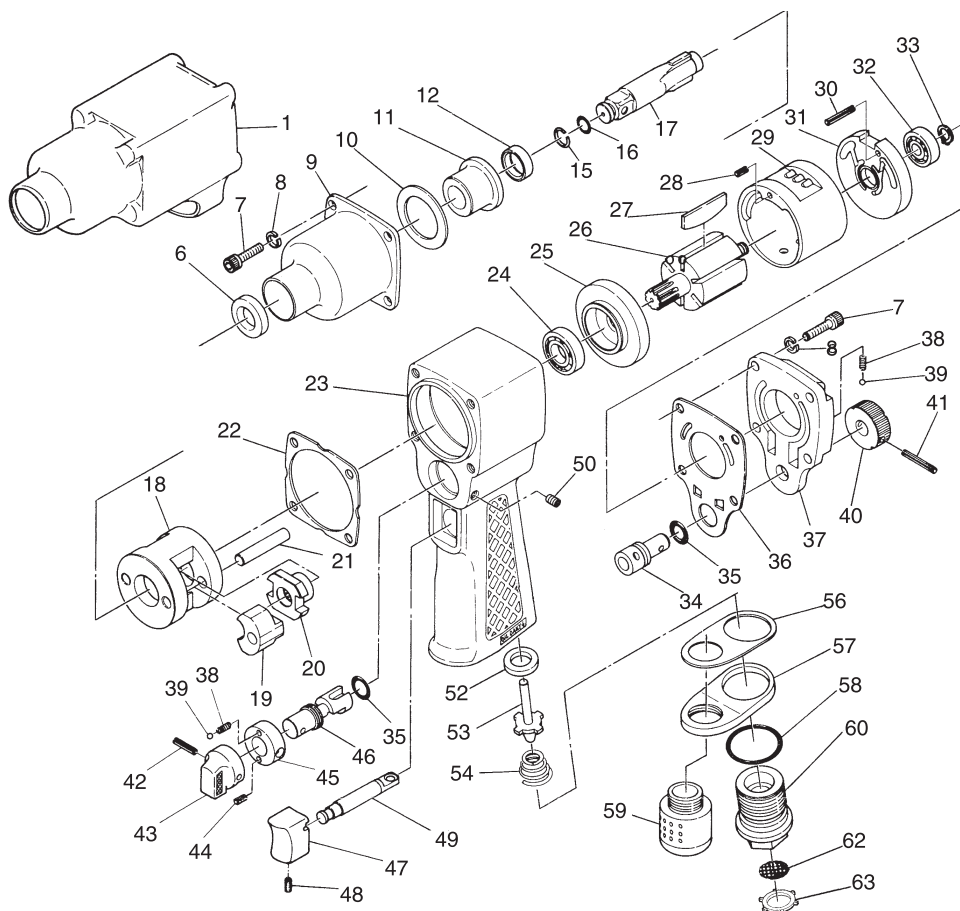

Ref. No.	Parts No.	Description	Q'ty	Ref. No.	Parts No.	Description	Q'ty
1	458-58	Housing Cover	1	35	P-8	O-Ring	2
6	450-17	Oil Seal	1	36	458-3	Motor Gasket	1
7	Z-1024--150	Cap Screw	8	37	458-2	Housing Cap	1
8	HSW-50	Washer	8	38	960-50	Spring	2
9	458-30	Hammer Housing incl. Bush, Oil Seal & Spacer (450-17, 450-20, 458-59)	1	39	SB-1/8	Steel Ball	2
10	458-59	Spacer	1	40	911-37	Regulator Dial	1
11	450-20	Anvil Bushing	1	41	30-20	Roll Pin (3φ 20mm)	1
12	450-54	Collar	1	42	30-18	Roll Pin (3φ 18mm)	1
15	450-10	Socket Retainer Ring	1	43	458-22	Reverse Lever	1
16	450-11	O-Ring	1	44	30-6	Roll Pin (3φ 6mm)	1
17	452-2	3/8" Sq Anvil	1	45	458-25	Spacer	1
18	452-1	Hammer Cage	1	46	458-21	Reverse Valve	1
19	450-51	Hammer Dog	2	47	458-27	Trigger	1
20	452-3	Cam	1	48	R-M40--60	Set Screw	1
21	450-52	Hammer Pin	2	49	458-28	Valve Pin	1
22	458-31	Hammer Housing Gasket	1	50	R1-M50--60	Set Screw	1
23	458-1	Motor Housing incl. Bushes (458-20, 458-29, 960-36)	1	52	960-34	Valve Seat	1
24	EE-3	Ball Bearing	1	53	960-35A	Valve A'ssy incl. Roll Pin (30-32)	1
25	458-4	Front Plate	1	54	991-8	Valve Spring	1
26	458-7	Rotor	1	56	458-46	Exhaust Gasket	1
27	458-8	Rotor Blade	6	57	458-45	Exhaust Retainer	1
28	25-8	Roll Pin (2.5φ 8mm)	1	58	991-7	O-Ring	1
29	458-6	Cylinder	1	59	103-1	Muffler	1
30	25-15	Roll Pin (2.5φ 15mm)	1	60	991-5SC	Inlet Bushing incl. Screen (680-28A) & Retainer(CRTW-12)	1
31	458-5	Rear Plate	1	62	680-28A	Screen	1
32	626	Ball Bearing	1	63	CRTW-12	Retainer	1
33	JS-6	Retaining Ring	1				
34	458-14	Air Regulator	1				